Chapter 5

Raw Meal Homogenization

A Survey on Homogenising and Blending Silos and their Operation

F. Bucher
PT 98/14361/E

1. Introduction	273
2. Compositional uniformity and Blending Factor	274
3. Silo Concepts For Raw Meal Beneficiation	277
3.1 Air-fluidized Systems	277
3.1.1 Process Concept	277
3.1.2 Design concepts	279
3.1.3 General Design Characteristics:	283
3.1.4 Valuation of the air-fluidised silo concept	283
3.2 Aerated gravity Systems	283
3.2.1 Process Concept	283
3.2.2 Design Concepts	286
3.2.3 General Design Characteristics:	289
3.2.4 Valuation of the aerated gravity silo concept	289
3.2.5 Limits in blending efficiency	291
4. Kiln Dust Handling	300
4.1 Compositional characteristics of kiln dust	300
4.2 Conceptual set-up of Kiln Dust handling systems	301
4.2.1 The separate kiln dust silo concept	301
4.2.2 The silo by-pass concept	303
4.2.3 The kiln dust dilution concept	305
5. annex	307
5.1 Annex 1	307
5.2 Annex 2	308
5.3 Annex 3	309

Summary

In Cement Industry raw meal blending or homogenisation is always done in silos. It is the last beneficiation step in the line of the raw mix preparation processes installed with the aim to reduce the residual (relatively short-term, high frequent) compositional variations observed for the raw meal produced in the raw mill. The raw meal reclaimed from such blending or homogenisation silos will then be fed to the kilns without further beneficiation. Therefore it is a challenge for all cement plant operators to achieve for the raw meal ex blending or homogenising silo a quality that meets narrow uniformity specifications regarding chemical composition and physical characteristics. This as a prerequisite for achieving steady process conditions for the kiln.

The paper gives a survey on the silo concepts used in raw meal beneficiation as well as their valuation.

The beneficiation efficiency achieved with such silos is not only function of the selected silo configuration but also of the kind of compositional disturbances produced in raw mix composition. The major lesson to learn is that the raw meal beneficiation silos can not be blamed for all the errors committed in raw mix composition. Hints regarding optimum operation of raw meal silo systems are given.

1. INTRODUCTION

In Cement Industry raw meal blending or homogenisation is always done in silos. It is the last beneficiation step in the line of the raw mix preparation processes (acc. Fig. 1) installed with the aim to reduce the residual (relatively short-term, high frequent) compositional variations observed for the raw meal produced in the raw mill. The raw meal reclaimed from such silos will then be fed to the kilns without further beneficiation. Therefore it is a challenge for all cement plant operators to achieve for the raw meal ex blending or homogenising silo a quality that meets narrow uniformity specifications regarding chemical composition and physical characteristics. This as a prerequisite for achieving steady process conditions for the kiln.

Besides final compositional beneficiation blending and homogenising silos serve as intermediate stores separating the two continuous processes raw grinding and clinker burning which are not necessarily operated at similar rates.

2. COMPOSITIONAL UNIFORMITY AND BLENDING FACTOR

In cement industry it is common to specify kiln feed uniformity

- ◆ in terms of variations in clinker compounds (%CaO; %CaCO₃ (titration)) or
- ◆ in terms of clinker moduli (%LSF; %C₃S; etc)

using simple statistical terms such as the Average and the Standard Deviation.

The simplest and most common statistical measure is the Average or Mean. Given a set of N measurements, X₁, X₂, ..., X_N the mean value X is given by

$$\bar{X} = \frac{1}{N}(X_1 + X_2 + \dots + X_N) = \frac{1}{N} \sum_{i=1}^N X_i \quad (1)$$

Deviations from the mean are expressed in terms of the Standard Deviation S, given by

$$S = \sqrt{\frac{(X_1 - \bar{X})^2 + (X_2 - \bar{X})^2 + \dots + (X_N - \bar{X})^2}{N-1}} \quad (2.1)$$

or

$$S = \sqrt{\frac{\sum_{i=1}^N (X_i - \bar{X})^2}{N-1}} \quad (2.2)$$

The difference between each measurement X_i and the mean value X are squared so that positive and negative fluctuations above and below the mean do not cancel each other. The square root of the sum of the squared variations is then divided by the number of measurements N to obtain an average measure of variation, having the same units as the measured quantity.

The Standard Deviation S allows for the following simple interpretation:

- ◆ the characteristic tested of 68 % of all samples will fluctuate within a range of ± 1S
- ◆ the characteristic tested of 95% of all samples will fluctuate within a range of ± 2S
- ◆ the characteristic tested of 99 % of all samples will fluctuate within a range of ± 3S

The natural and induced blending which occurs at a particular beneficiation stage may be expressed by a Blending Factor BF defined as the ratio of the incoming and discharge Standard Deviations:

$$BF = \frac{S_{in,corr}}{S_{out,corr}} = \frac{\sqrt{S_{in,measured}^2 - S_{in,error}^2}}{\sqrt{S_{out,measured}^2 - S_{out,error}^2}} \quad (3) \quad \text{as blending/homogenising factor}$$

The Standard Deviations as measured need correction for sampling and analysis errors for which the silo can not be blamed. For determining the sampling and analysis error Merks¹ double sampling method is proposed. Evaluation of the test is given in Annex 1.

¹ JW Merks, Sampling and Weighing of Bulk Solids, Trans Tech Publications 1985

In Cement Industry daily practice demonstrate that compositional variations of the kiln feed have an adverse effect on kiln operation (coating formation, temperature profile, encrustation due to unstable evaporation of the circulating elements (SO₃, Alkalis, Cl⁻), etc.) and thus on brick life and kiln availability. The problem gets even more complex by the fact that not all industrial raw meals need to be uniform to the same extent. Easy burning raw mixes tolerate fluctuations in a wider range than difficult burning raw mixes.

Nevertheless it is useful to have some guide values regarding tolerable compositional fluctuations at hand. In Cement Industry it is generally accepted that no further improvement of raw meal quality can be expected by additional blending/homogenisation for the kiln feed variations given in below table.

Characteristic		analytical error excluded [standard deviation s]	analytical error included [standard deviation s]
CaCO ₃	%	≤ 0.2	≤ 0.25
CaCO ₃ max.	%	≤ 0.3	≤ 0.35
CaO	%	≤ 0.11	≤ 0.15
CaO max.	%	≤ 0.17	≤ 0.2
SiO ₂	%	≤ 0.1	≤ 0.15
Al ₂ O ₃	%	≤ 0.07	≤ 0.12
Fe ₂ O ₃	%	≤ 0.04	≤ 0.04
LSF	%	≤ 1.0	≤ 1,5
SR	%	≤ 0.04	≤ 0.06
AR	%	≤ 0.06	≤ 0.08

Figure 1: A cement works blending / homogenizing sequence

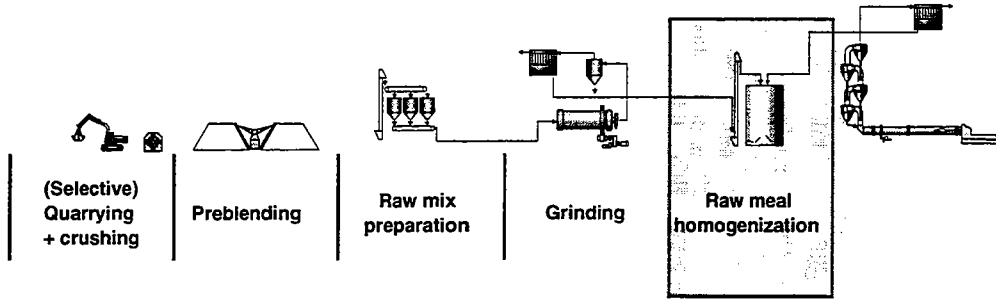

3. SILO CONCEPTS FOR RAW MEAL BENEFICIATION

The silo concepts used in raw meal beneficiation can be classified according to the kind of the working principle applied into the following categories:

- ◆ Air-fluidised systems,
- ◆ Aerated gravity systems,
- ◆ Non-aerated gravity systems.

3.1 Air-fluidized Systems

3.1.1 Process Concept

Air-fluidised homogenising systems aim at raw meal beneficiation prior to be stored. A typical system set-up is the two-storey silo concept with the homogenising silo installed on top of a storage silo (Fig. 2).

Figure 2: Air Fluidized silo systems - Batchtype, tow storey arrangement

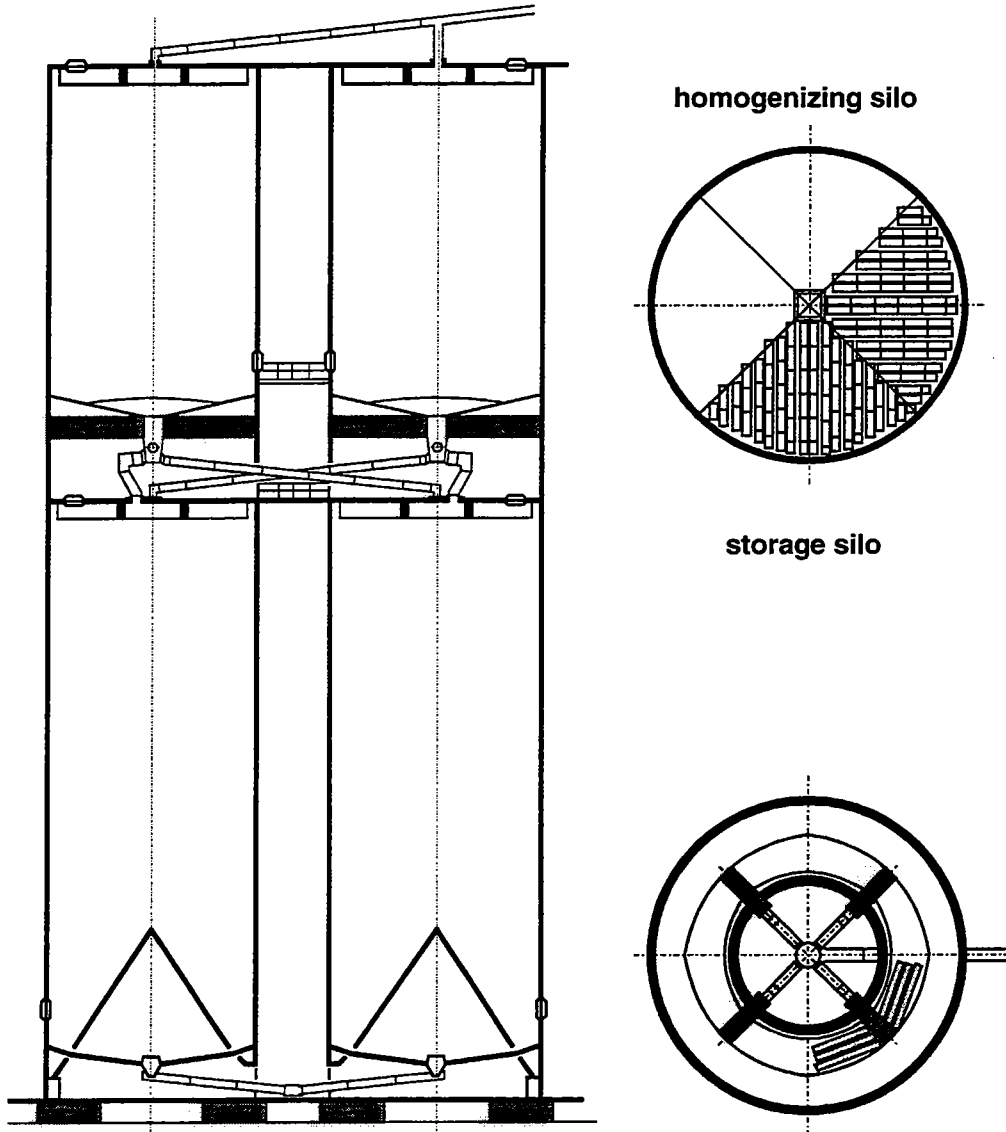

Such systems follow the concept of the fully agitated mixer. For that purpose compressed air is introduced through a permeable media covering the silo's bottom. Aeration causes the cement raw meal to behave as a liquid. By variation of the airflow through the raw meal bed the individual particles are forced to move relative to each other what result in efficient homogenisation (Fig. 3).

Figure 3: Air fluidized silo systems - The Quadrant System

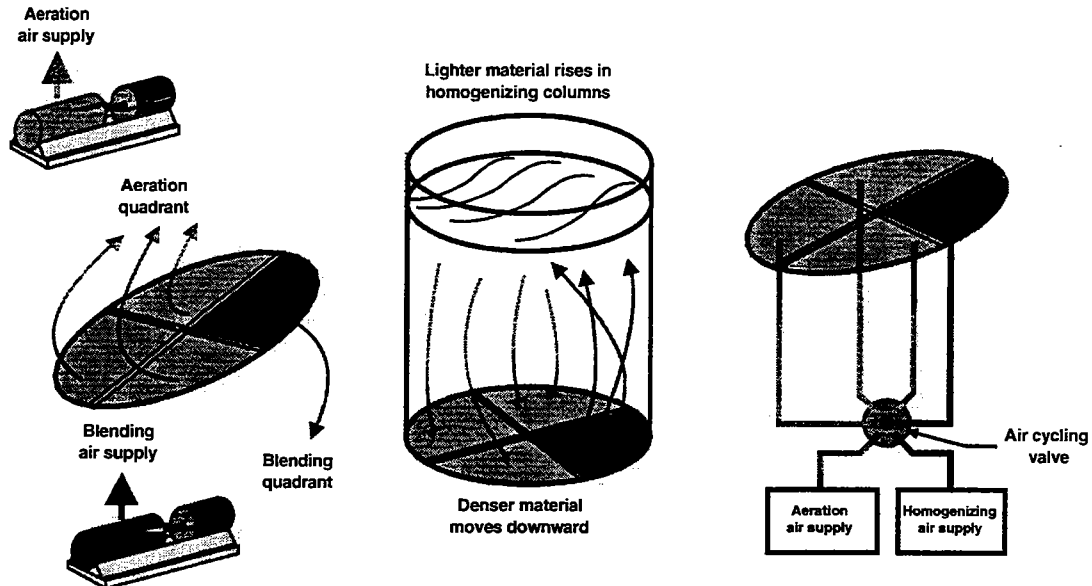

As to achieve a variation of the airflow through the raw meal bed the silo bottom is divided into segmented areas, typically into quadrants or octants. Typically two air compressors are installed for aeration air supply. Homogenising air is supplied at a high rate and a high pressure into the selected homogenising sector (one quadrant or octant) and creates by this an extremely active, low-density column of raw meal. At the material surface this upward moving blending column spills onto denser, downward moving material located over the aeration sectors. Air supply to the aeration sectors is at much lower rate and at lower pressure. Active homogenising aeration is switched systematically at regular time intervals by means of a special valve sector by sector.

The design of storage silos is quite similar to the design of continuous blending silos, which will be discussed in Para 3.2.

3.1.2 Design concepts

Fluidised homogenising silos are designed according two concepts:

- ◆ as batch-type silos or
- ◆ as continuous-overflow type silos.

3.1.2.1 The batch-type silo concept

◆ Homogenising effect

The homogenising effect of air-fluidised silo system when operated in batch-wise mode may be as high as 15:1. Air fluidised silo systems are thus most efficient in raw meal beneficiation but one has to accept small compositional differences between the single batches (Fig. 4). These differences become the smaller the closer the goal value for raw mix composition is achieved by component adjustment at mill inlet.

Figure 4: Homogenizing / blending effect of raw meal silos

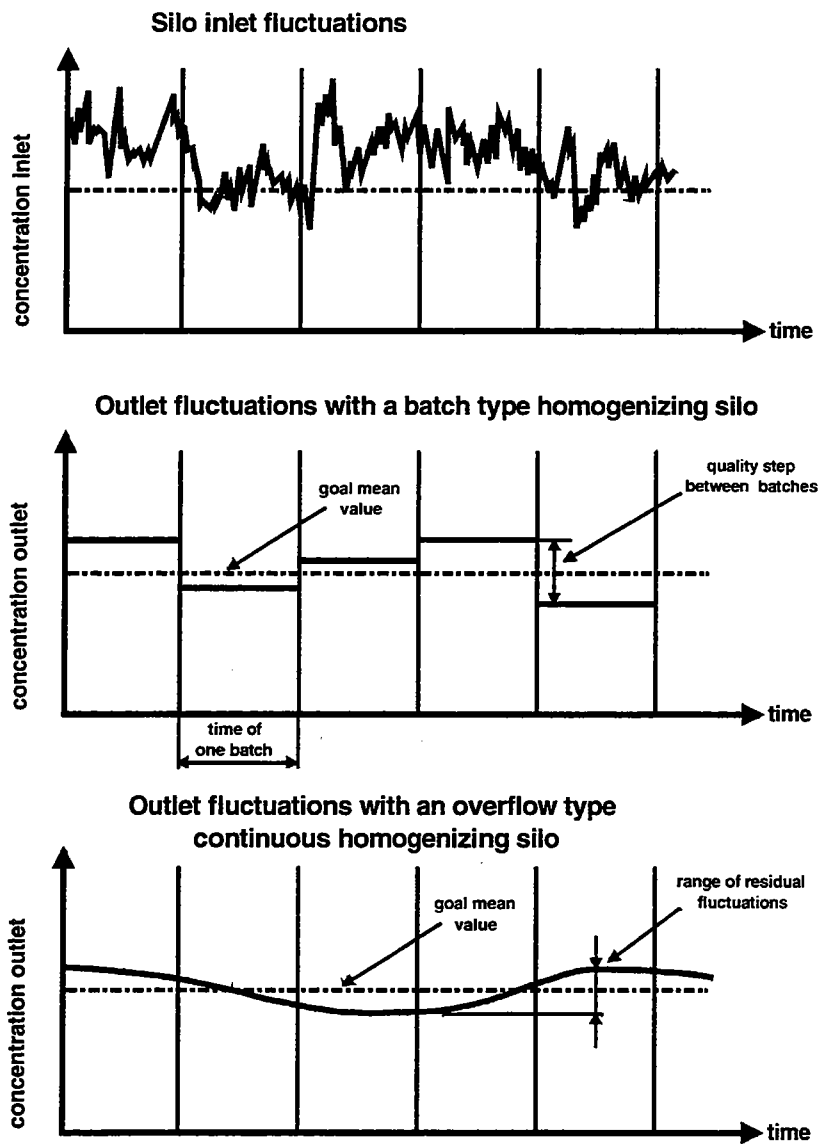

◆ Energy consumption

Energy consumption with air-fluidised silos is in a range of 0.7-1.0 kWh/t, thus important energy consumers. Nevertheless batch type operation of homogenising silos may be optimised regarding power consumption just by limiting compressor run-time to the minimum required for achieving a sufficient compositional uniformity. It is often observed that compressor run-time is excessive without that raw meal quality can be further improved (Fig. 5)

Figure 5: Air fluidized silo systems - The Varioflow System

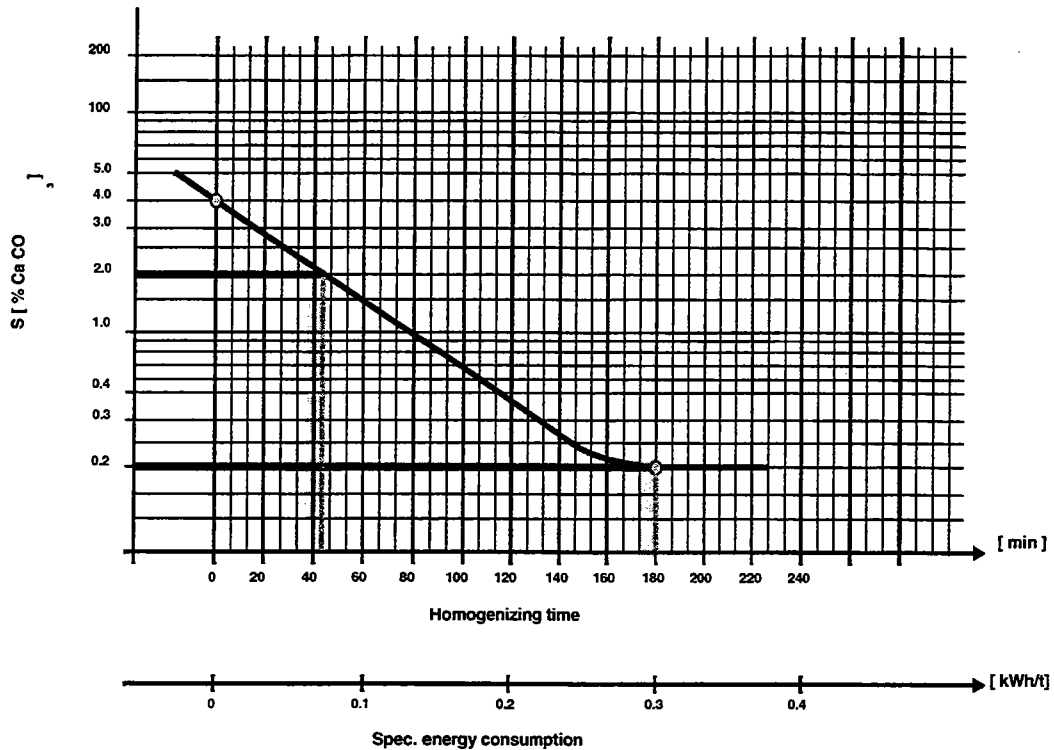

Suppliers:

- ◆ BMH-CPAG
- ◆ IBAU
- ◆ Fuller-Kovako

3.1.2.2 The continuous-overflow concept

◆ Homogenising effect

The continuous-overflow operation mode was developed as to overcome the step type quality changes common for batch-type silo systems (Fig.4). Nevertheless one has to accept a slightly reduced homogenising efficiency due to short-circuit product leaving the silo immediately without being homogenised.

◆ Energy consumption

With the compressors permanently running energy consumption of overflow-type silos is in a high range of 1-1.5 kWh/t, thus significantly higher compared to the batch-type silos

Suppliers:

- ◆ BMH-CPAG
- ◆ IBAU
- ◆ Fuller-Kovako

3.1.2.3 The Vario-Flow concept

The Vario-Flow silo concept (Fig. 7), a further development of the overflow silo concept, was developed as to reduce system energy consumption. Again the silo bottom is divided in quadrant areas but each of the quadrants is in addition divided into a homogenising and an aeration area. By this air supply may be reduced what results in reduced system energy consumption.

Figure 6: Air fluidized silo systems - The Varioflow System

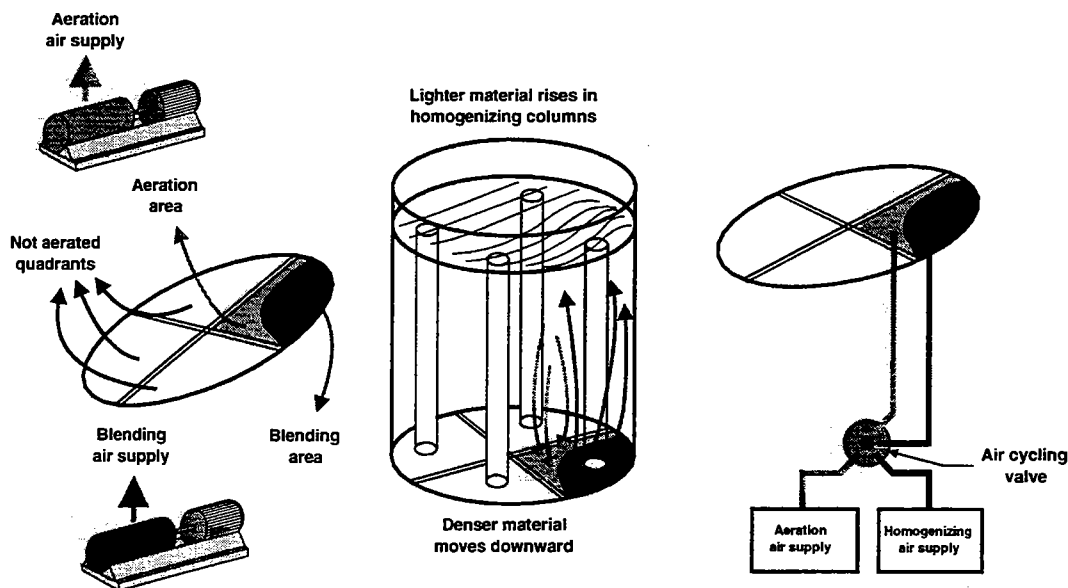

- ◆ The homogenising effect is similar as with a conventional overflow system.
- ◆ Energy consumption is about 0.9 kWh/t.
- ◆ Supplier:
- ◆ BMH-CPAG

3.1.3 General Design Characteristics:

Design characteristics		Homogenising Silo	Storage Silo
capacity (hours of mill operation)	h, d	10-12 h	1-3 d
height/diameter ratio	-	1.2-1.5 : 1	up to 2.5:1
net aeration area (% of bottom area)	%	50-70	35-50
active aeration air rate (specific)	m ³ /minm ²	1.5-2.0	
active aeration air pressure	bar	up to 2.5	
aeration air rate (specific)	m ³ /minm ²	1.0-1.5	1.0-1.5
aeration air pressure	bar	0.6-0.8	0.6-0.8
energy consumption (specific)	kWh/t	0.9-1.5	0.1-0.3
range of fluctuations that can be reduced	h	10-12	
homogenising effect	-	up to 15:1	

3.1.4 Valuation of the air-fluidised silo concept

- + most efficient raw meal homogenising system
- high energy consumption, above all when operated in a continuous-overflow mode
- application limited to capacities of about 2000 t corresponding to 3000 t/d clinker production lines
- high investment

Development of the air-fluidised silo concept has to be seen in context with the introduction of the dry process in Cement Industry. At that time efficient raw meal blending was indispensable as a consequence of the non-availability of efficient raw material preblending systems. The air-fluidised silo systems lost ground in favour of continuous blending silos (i.e. inverted cone type gravity systems) with the introduction of efficient preblending systems. New air fluidised homogenising silos will hardly be installed anymore in Cement Industry.

Still operational air fluidised homogenising silos need not to be modified at all costs. But there operating cost may in many cases be reduced by optimising the homogenising sequence. In that respect batch-wise operation at shortest homogenising time is preferred to a continuous-overflow operating mode.

3.2 Aerated gravity Systems

3.2.1 Process Concept

Aerated gravity systems aim at raw meal beneficiation and intermediate storage in one common silo.

The system follows the concept of a blender. For that purpose the raw meal is fed into the silo in horizontal layers. When reclaiming meal from the silo a funnel will form on top of the discharge point at the product surface. The declining funnel surface cause blending of particles originating from different layers when sliding down the slope to into the transport channel. (Fig. 8).

Figure 8: Aerated gravity systems

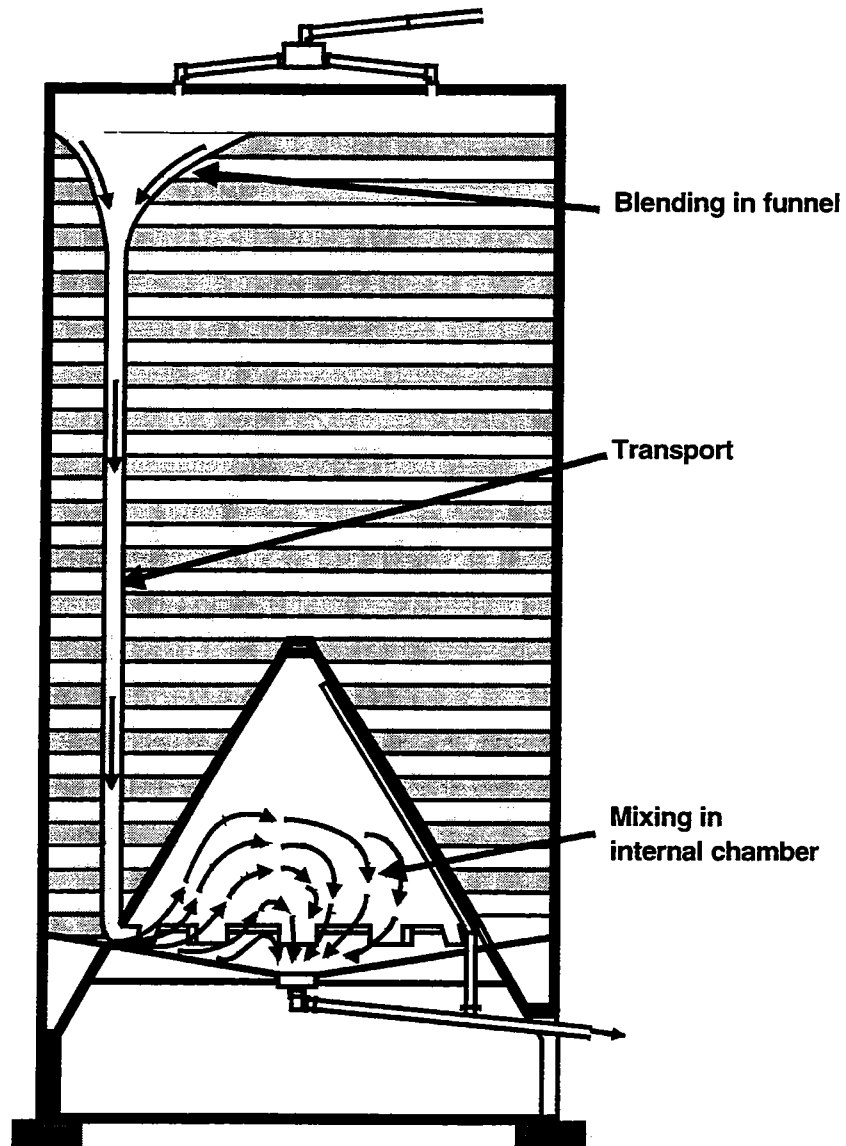

Horizontal layering of the raw meal is achieved while feeding the silo via a spider-type air slide system. Cement raw meal activation for discharge is achieved by slight aeration. For that purpose compressed air is introduced through a permeable media covering the silo bottom. The silo bottom itself is divided into segmented areas, the number of which is a function of the silo diameter. Aeration air is supplied at a low rate and a low pressure into the selected aeration sector for raw meal activation. This air leaves the silo together with the activated raw meal; it will not penetrate into the raw meal column on top of the activated sector. Aeration is switched systematically by means of a special valve sector by sector.

The blending potential of the aerated gravity silos is limited compared with that of air-fluidised homogenising silos (Fig. 13).

Figure 13: Homogenizing / blending effect of raw meal silos

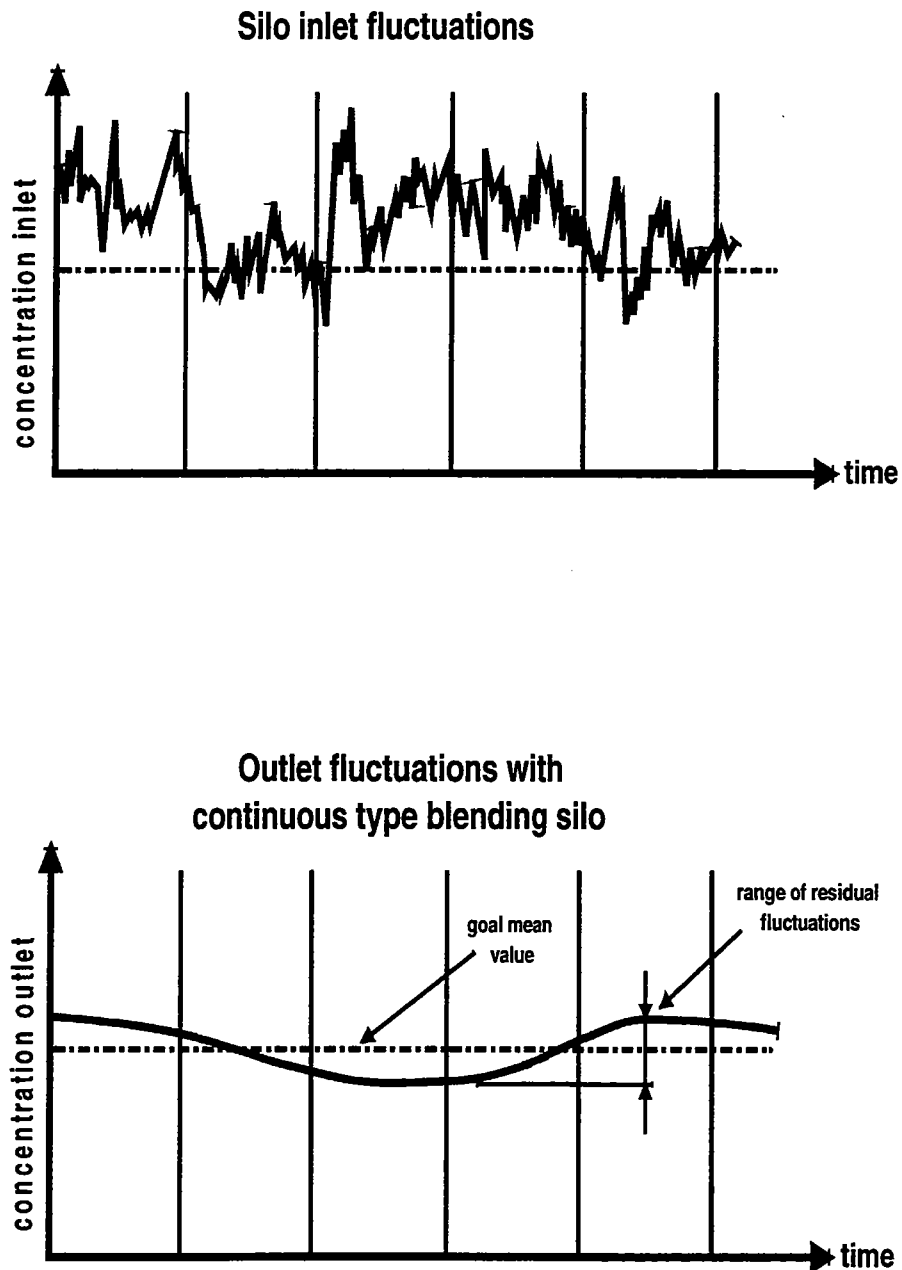

3.2.2 Design Concepts

Aerated gravity silo systems are designed according to three concepts:

- ◆ as inverted cone silos or
- ◆ as central chamber silos,
- ◆ as multiple-outlet silos.

3.2.2.1 *The inverted cone concept*

The inverted cone silo (Fig. 9.1) represents the pure concept of the aerated gravity silo. The silo is, as said by its name, equipped with a huge inverted cone covering most of its centre bottom area. The remaining annulus is divided into segmented areas that are covered by open airslides. Each sector is equipped with its own outlet. Raw meal is activated predominantly at the silo's circumference by sequential air supply to the individual sectors, avoiding by this the formation of huge zones of stagnant product.

- ◆ Blending effect: max. 5:1
- ◆ Energy consumption: 0.1-0.2 kWh/t

System suppliers:

- ◆ BMH-CPAG
- ◆ IBAU
- ◆ Fuller-Kovako
- ◆ Krupp-Polysius tangential silos

3.2.2.2 *The central chamber silo concept*

The central chamber silo configuration (Fig. 9.2+3) refers to a concept that uses the inverted cone as a centre chamber for additional reduction of residual compositional short-term variations. The annulus is divided into segmented areas that are covered by open airslides as for the inverted cone configuration. Again raw meal is activated by sequential air supply to the individual sectors. Design of the central chamber differs in shape (conical or cylindrical) and volume. Compressed air is introduced for air-fluidisation through a permeable media (open airslides) covering the chamber bottom that is typically divided into quadrants. The aeration sequence for the central chamber is similar to that of air-fluidised silos as discussed in Para 3.1.

The blending potential of a central chamber silo is slightly better compared to that of a simple inverted cone silo.

- ◆ Blending effect: 5:1
- ◆ Energy consumption: 0.3 kWh/t

System suppliers:

- ◆ BMH-CPAG central chamber silos homogenising chamber silos
- ◆ Joh. Möllers

Figure 9: Continuous blending - type silos

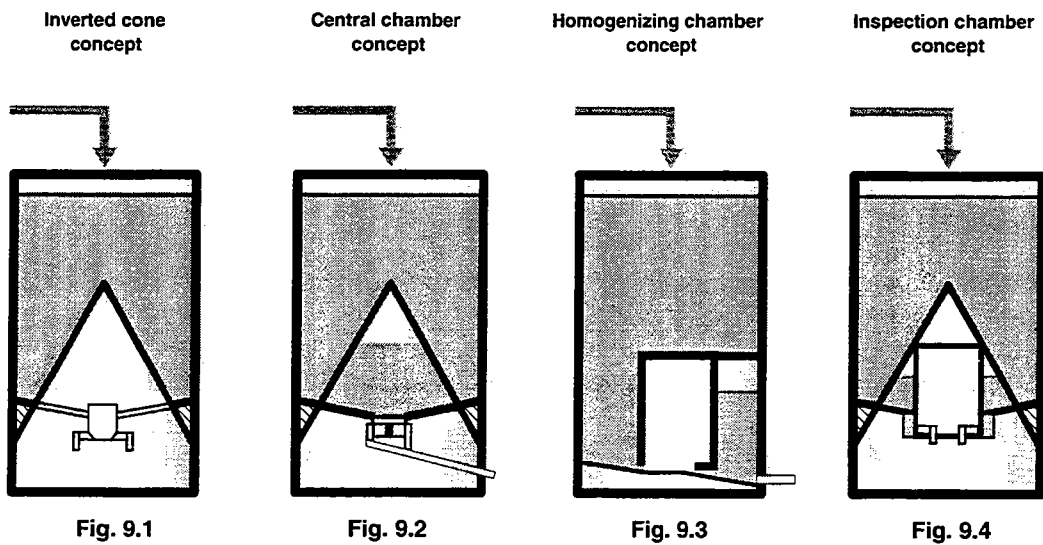

3.2.2.3 The multiple-outlet silo concept

Multiple-outlet type gravity silos follow the concept of blending the raw meal while it is discharged via different outlets at different rates.

- ◆ Blending effect: 5:1
- ◆ Energy consumption: 0.3 kWh/t

This type of silos is available in various configurations:

3.2.2.3.1 The FLS' Controlled Flow (CF) silo concept

The silo bottom of the CF silo (Fig.10) is divided into seven identical hexagonal sectors, each of which has its centre outlet covered by a pressure relief cone made of steel. Each of the hexagonal sectors is subdivided into six triangular segments all equipped with open aeration boxes. Raw meal extraction follows a sequence where three segments positioned at three different outlets are aerated at a time. From the outlets it is conveyed at different rates to the central mixing tank installed below the silo. The aeration sequence is cyclic in a way that all the 42 segments will be activated once within about 15 minutes.

Supplier:

- ◆ FLS

Figure 10:

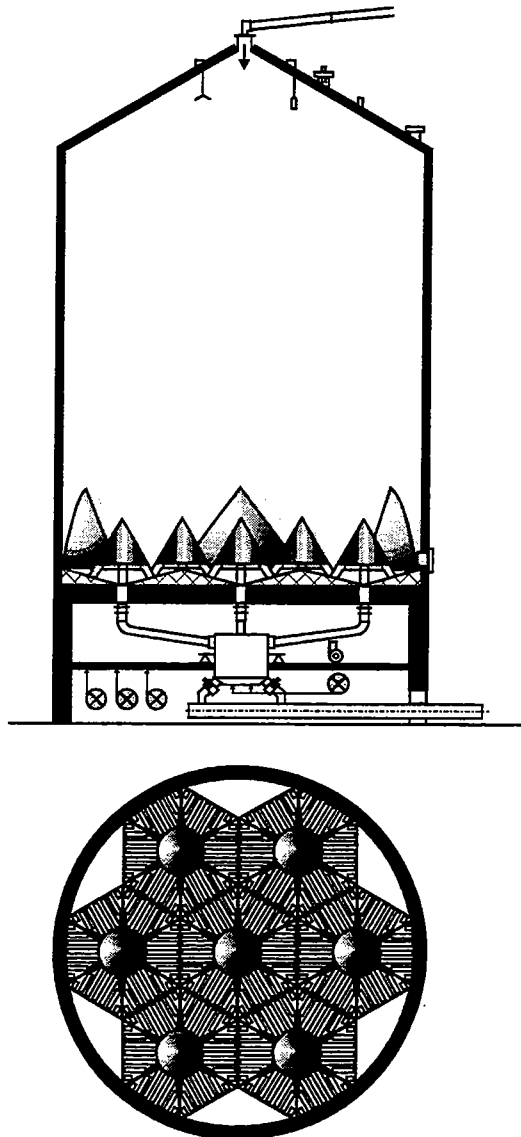

3.2.2.3.2 The Fuller-Kovako Random Flow silo concept

Again the silo bottom of the Random Flow silo is divided into a number of sectors. In addition these sectors are subdivided in six discharge zones and equipped with a closed collecting airslide. Each discharge zone has its pick-up point to the collecting airslide from which the raw meal is transferred to the centre mixing tank installed below the silo. Selective aeration is the means by which raw meal is discharged out of three different silo areas at a time. Again aeration sequence is cyclic.

The concept can easily be applied for upgrading existing fluidised blending silos.

Suppliers:

- ◆ Fuller Kovako
- ◆ Krupp-Polysius Multiflow silo

3.2.3 General Design Characteristics:

Silo design characteristics		Continuous Blending Silo
silo capacity	t	2'000-20'000
height/diameter ratio	-	up to 2.5:1
net aeration area (% of bottom area)	%	25-35(-50)
aeration air rate (specific)	m ³ /minm ²	1-1.5
aeration air pressure	bar	0.6-0.8
energy consumption (specific)	kWh/t	0.1-0.3
range of fluctuations that can be reduced	h	up to 5
homogenising factor	-	up to 5:1
Internal Chamber		
net aeration area (% of bottom area)	%	35-50
active aeration air rate (specific)	m ³ /minm ²	1.0-1.5
active aeration air pressure	bar	0.8
aeration air rate (specific)	m ³ /minm ²	1.0- 1.5
aeration air pressure	bar	0.6-0.8

3.2.4 Valuation of the aerated gravity silo concept

- + applicable for wide capacity ranges
- + low energy consumption
- + low investment
- limited raw meal beneficiation potential compared to the air-fluidised homogenising silos
- insufficient reduction of long-term, peak or step-type fluctuations

A comparison of aerated gravity systems versus air-fluidised systems is given in Fig.12.

Figure 12: Comparison of silo concepts: Homogenizing versus Blending Silos

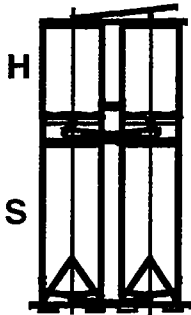
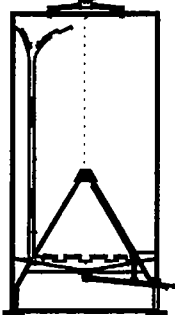
Silo configuration			
	<p style="text-align: center;">Two storey</p> <p style="text-align: center;">H S</p>		
Design Data <ul style="list-style-type: none"> • Capacity • Height/diameter ratio • Net aeration area (% of bottom area) 	10-12 h 1-3 d 1,2 : 1 2,2 : 1 Up to 70 25-35	0,5 - 3 d Up to 2,5 : 1 25-35-(50)	
Investment cost	100%		50%-60%
Aeration <ul style="list-style-type: none"> • Air rate per net aeration area • Air pressure • Spec energy consumption 	1,5 - 2,0m ³ /min m ² Up to 2,5 bar 0,7 - 1,5 kWh/t	1 - 1,5m ³ /min m ² Up 0,6 to 0,8 bar 0,1 - 0,3 kWh/t	
Performance <ul style="list-style-type: none"> • Range of fluctuations that can be reduced • Homogenizing/blending effect 	10-12 h Up to 15:1	Up to 4 h Up to 5:1	

Development of the aerated gravity silo concept started with the introduction of raw material preblending systems in the cement process out of the need to reduce power consumption for cement raw meal homogenisation. The increasing efficiency of such preblending systems went along with a gradual reduction of the size of blending silos. While sizing of blending silos was typically for holding a three days stock in the area 1960 to 1980 it is now as low as for holding a one-day stock.

3.2.5 Limits in blending efficiency

3.2.5.1 *The case of insufficient reduction of a peak disturbance*

The blending efficiency of a continuous blending silo is commonly given by the ratio of the silo inlet and outlet Standard Deviations for the selected compositional characteristic:

$$BF = \frac{S_{in}}{S_{out}}$$

The diagram given in Fig. 15 shows the example of the LSF fluctuations at silo inlet and how these fluctuations are reduced in function of the time. In the first part of the observed interval the inlet and the outlet fluctuation have the following values:

	Inlet	Outlet
mean	96.0	96.0
Standard Deviation	2.11	0.24

The blending effect of the silo calculates to be

$$BF = \frac{S_{in}}{S_{out}} = \frac{2.11}{0.24} = 8.8$$

Unfortunately this efficiency factor do not means that all compositional peaks fed into the silo are reduced by this factor. The second part of the observed interval illustrates the case of a huge peak (LSF=112.0) that has been produced and fed into the silo. Reduction of this peak is much less efficient (LSF=103.5). The corresponding blending effect calculates to

$$BF = \frac{112.0 - 96.0}{103.5 - 96.0} = 2.1$$

Continuous blending silos obviously reduce suddenly appearing compositional peaks much less than more or less stochastic short-term fluctuations.

The example demonstrates that compositional fluctuations of different kind are reduced with different efficiencies. The simple blending efficiency as defined by the ratio of the silo inlet and outlet Standard Deviations gives thus just a very general indication on the silo's blending behaviour. As to get more specific in this respect a more in depth investigation is required.

Figure 15: Homogenizing / blending effect of raw meal silos

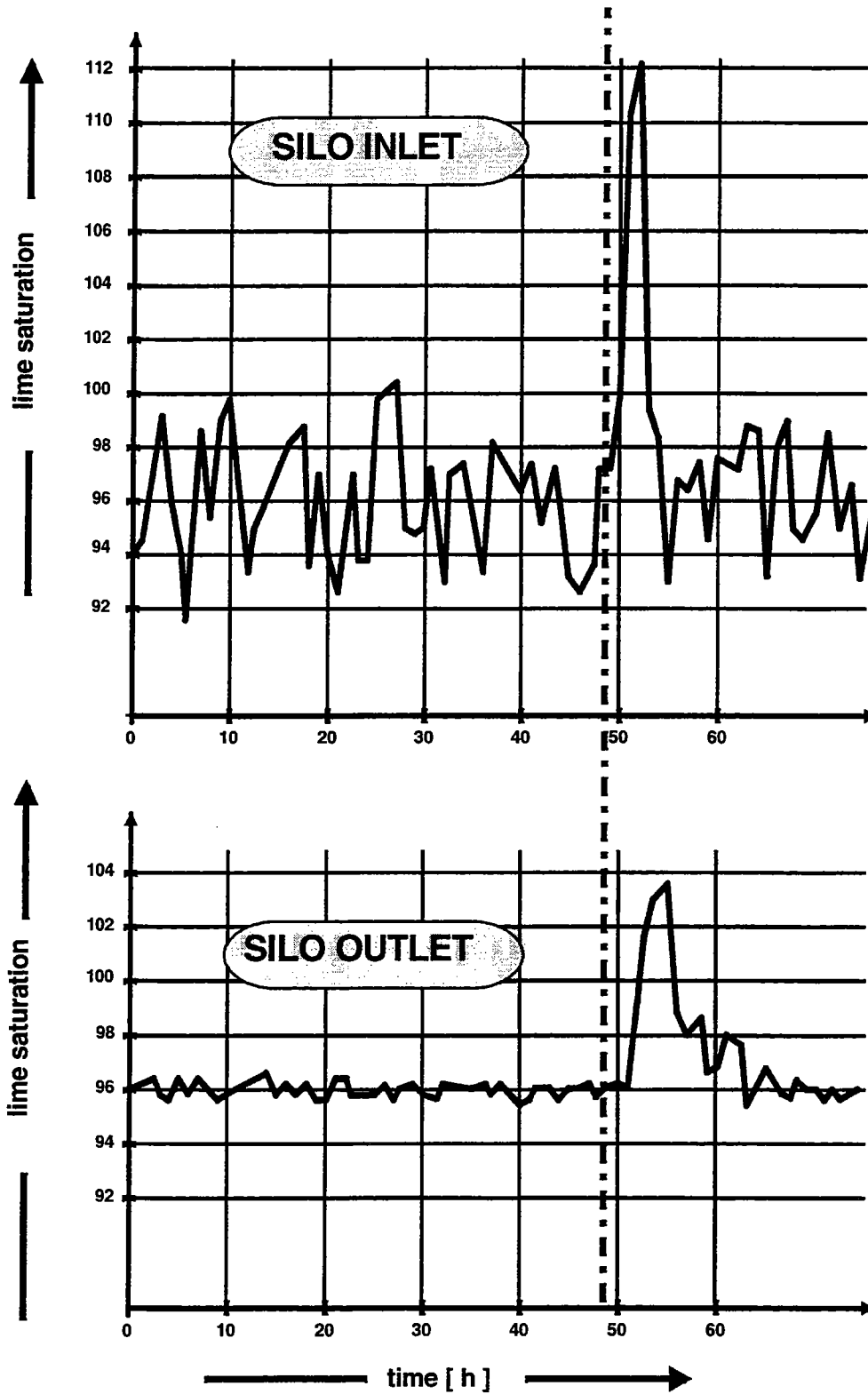

3.2.5.2 *“Holderbank’s” silo investigation*

Investigations in a silo’s blending behaviour are in that way complex as direct operation of the flow during silo operation is impossible. Again the only information available for evaluation is the information regarding the compositional variations in the silo feed and in the raw meal reclaimed. What we have done already some years ago was to test a silo’s response on different types of on purpose created disturbances like

- ◆ suddenly appearing peak-type disturbances and
- ◆ periodic oscillations.

Suddenly appearing disturbances can mathematically be divided into a sum of single impulse functions. Knowing a silo’s response on one inlet impulse function allows for predicting the silo outlet function of any suddenly appearing disturbance. (Fig. 16)

Figure 16: Silo response to a suddenly appearing disturbance

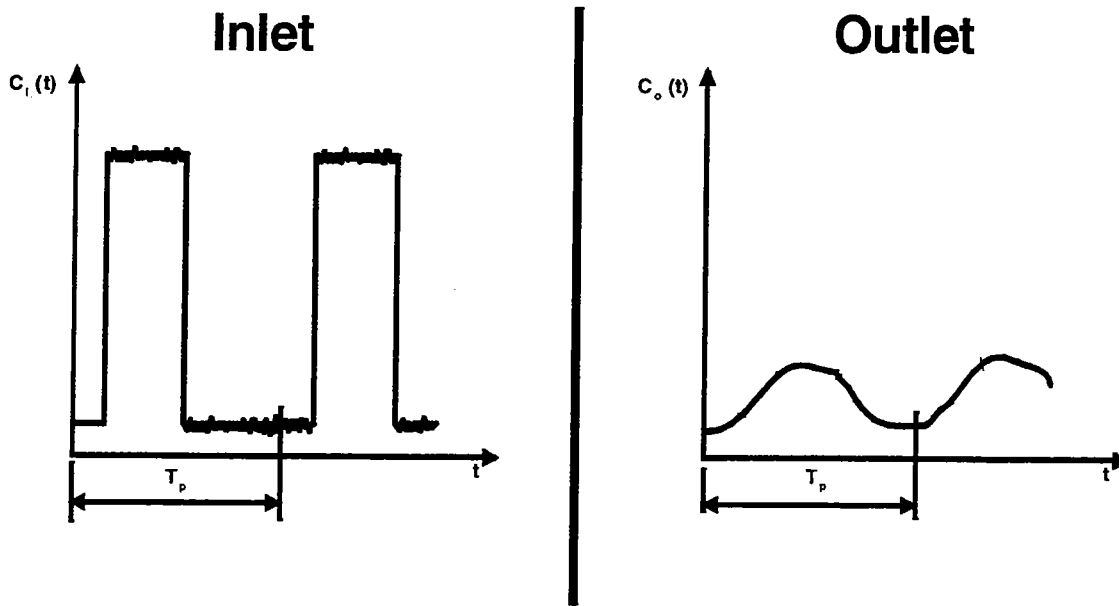

$$C(t) = \frac{A_o}{2} + \sum_{n=1}^{\infty} [A_n \cdot \sin(n \cdot \omega_o \cdot t + \phi_n)]$$

with $\omega_o = \frac{2 \cdot \pi}{T_p}$

n	A_n	ϕ_n
1
2
3

n	A_n	ϕ_n
1
2
3

If raw meal's composition out of the raw mill varies like a harmonic oscillation (e.g. like a sinus function) the raw meal exit function (at silo outlet) will also be harmonic with the same frequency but with reduced amplitude and with a phase shift. Real periodic disturbances are not exactly harmonic functions but can according to the law of Fourier be divided into as um of harmonic functions. Again the silo answer to a harmonic inlet function can be calculated from the answer to one single impulse function (Fourier-Laplace Transformation). (Fig. 17)

Figure 17: Silo response to a harmonic oscillation

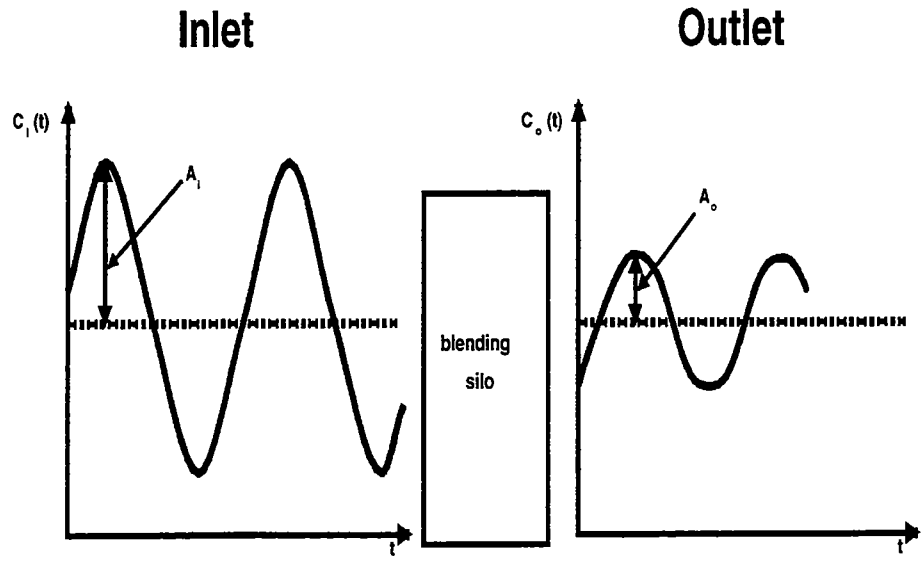

$$C_i(t) = A_i \cdot \sin(\omega t)$$

$$C_o(t) = A_o \cdot \sin(\omega t + \varphi)$$

$$e = \frac{A_i}{A_o}$$

$$G = \frac{A_o}{A_i} = \frac{1}{e}$$

Hence it follows that with an impulse function as inlet disturbance the behaviour of the silo can be sufficiently investigated and the blending efficiency for all cases predicted. Applying Fourier Transformation on both the silo inlet and outlet functions, for each function a discrete spectrum of amplitudes is obtained (Fig. 18). Just by dividing the two spectra of amplitudes the silo's frequency response G can be calculated. Its bending factor is the reciprocal of G .

Figure 18: Spectrum of amplitudes - Frequency response

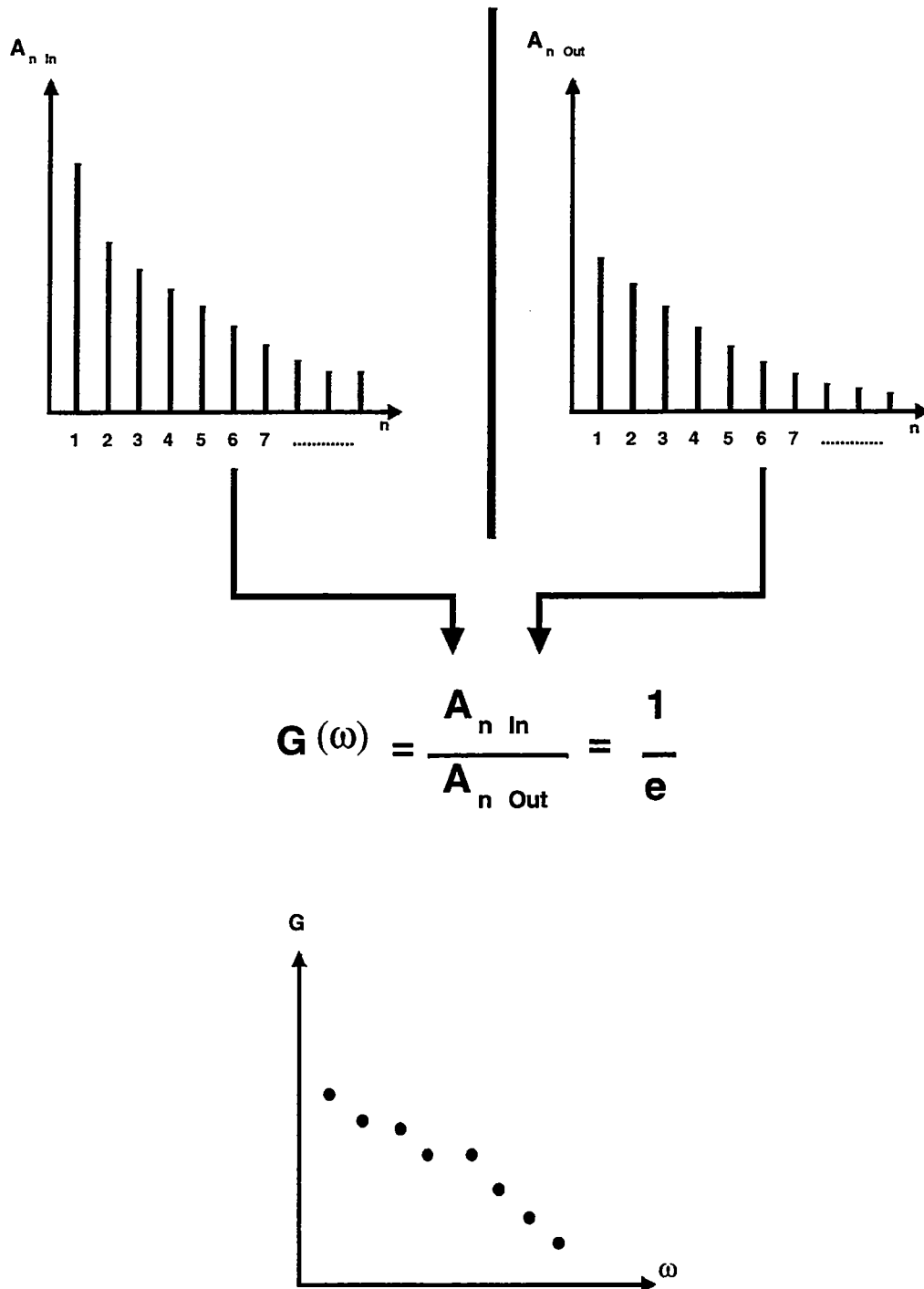

In a further step a mathematical model of second order (Fig. 19) was developed for the simulation of the real behaviour of a continuous blending silo.

Figure 19:

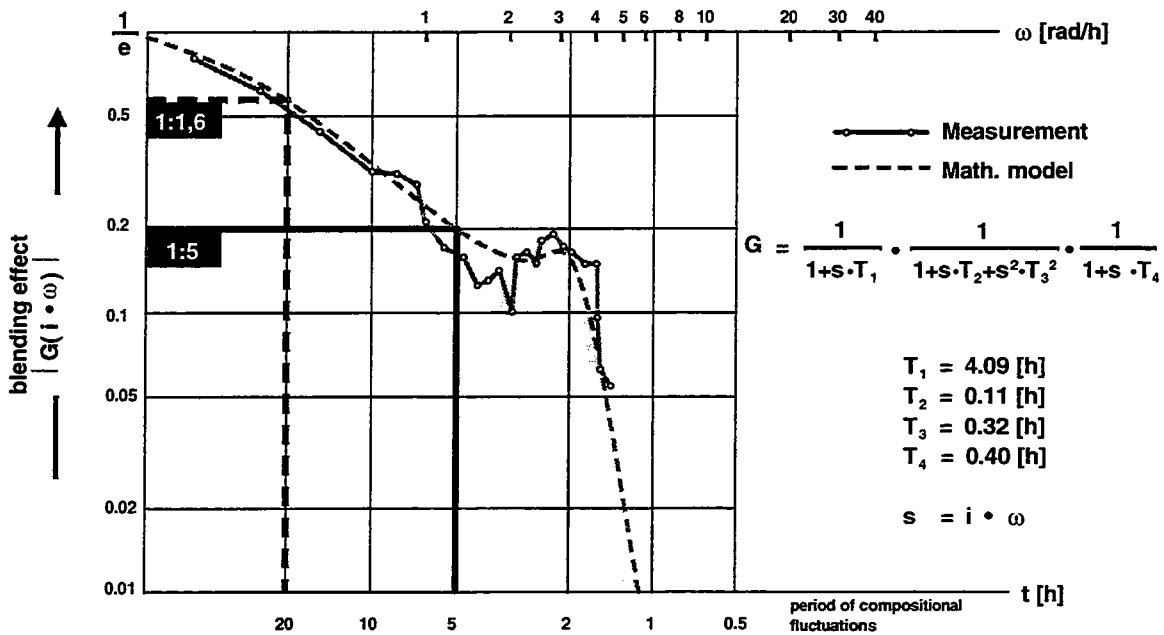

The investigation showed the following results:

- ◆ Most efficient blending takes place at product surface in the silo when a funnel is formed. Feeding raw meal into the silo in horizontal layer is therefore prerequisite for a good blending effect.
- ◆ In the transporting channel no significant cross-mixing takes place. This part is of inferior influence on blending efficiency.
- ◆ Due to the raw meal’s limited residence time in a central chamber contribution of this chamber to the meal beneficiation is limited to very short-term fluctuations.

3.2.5.3 Lessons to learn for silo operation

The diagram in Fig. 19 indicate that all fluctuations with a periodical time shorter than about 5 h are reduced with an efficiency better than 5:1. The first part in the diagram (Fig. 15) represents efficient reduction of such short-time fluctuations.

Long-term fluctuations with periodical times exceeding 5 h are not reduced sufficiently. A compositional oscillation for example with a periodical time of 20 h is reduced with a low efficiency of just 1.16:1. In this case the silo has no chance to achieve a sufficient blending result. The only way to improve the situation is to cut any long-term fluctuations by frequent adjustment of raw mix composition, i.e. by frequent adjustment of the weigh feeder set points.

Different to oscillating disturbances are suddenly appearing peaks due to reasons such as

- ◆ cut of a new preblending pile,
- ◆ loss of one raw mix component,
- ◆ inadequate feeder adjustment,
- ◆ inadequate kiln dust handling when changing from a compound to a direct operating mode.

Continuous blending silos are not in a position to reduce the peak disturbances sufficiently. The only efficient measure to compensate for such peak disturbances is by creation of a defined counter-peak by making adequate adjustments to the raw mix composition (Fig. 20).

Figure 20: Effect of inadequate raw mix preparation

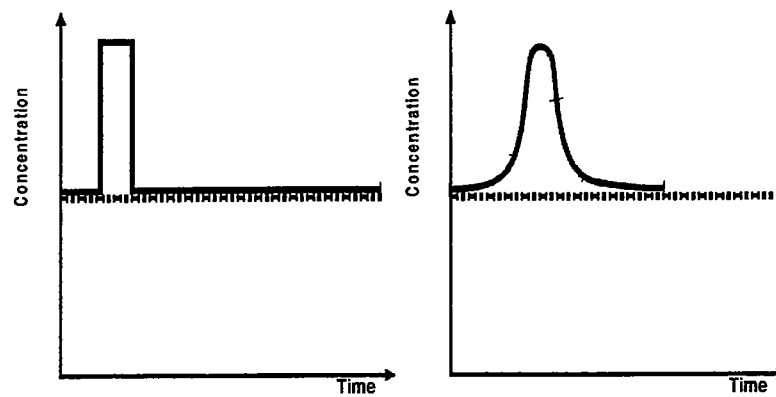

Inlet
Peak disturbance

Outlet
Reaction on peak

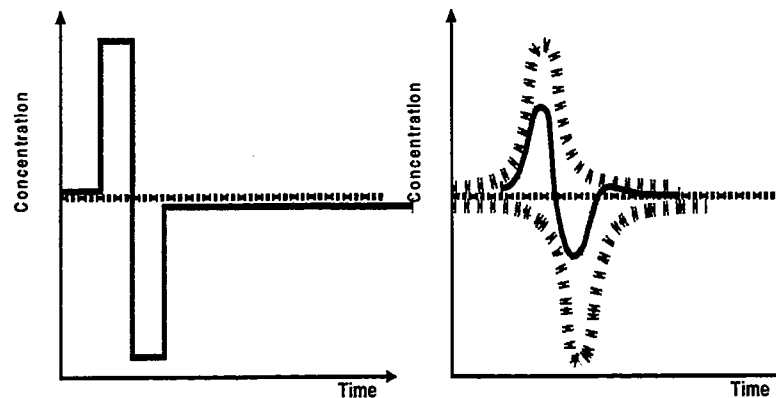

Inlet
Peak disturbance
contrary peak
(Operators intervention)

Outlet
Reaction with intervention
of operator

4. KILN DUST HANDLING

4.1 Compositional characteristics of kiln dust

Switching from a compound operation mode (kiln and raw mill in operation) to a direct operation mode (kiln only in operation with the raw mill stopped) or vice versa may result in an abrupt compositional variation of kiln feed, particularly of its Lime Saturation Factor (LSF). The reason for is that kiln feed and kiln dust are different in their chemical composition. Typical LSF data of some 4 stage preheater kilns are given in below table.

Plant	Kiln No.	LS kiln feed	LS recirculated dust
AL	1	95.7	119.5
AP	1	93.4	110.4
AP	2	93.4	110.1
AT	1	93.2	88.6
EC	3	92.1	81.3
GM	4	95.3	97.3
HD	2	96.1	93.3
KA	6	119.7	87.4
MI	3	93.9	97.4
OZ	4 + 5	93.1	93.9
PL	1	90.8	70.8
RE	3	93.1	103.9
RK	1	91.3	93.0
UV	3	90.2	81.3

As can be seen from above data LSF of kiln dust may differ from LSF of kiln feed quite significantly (in a $\pm 20\%$ range). There is no general rule allowing for predicting the LSF of kiln dust based on the compositional data of kiln feed.

A $\pm 1\%$ standard deviation of LSF in kiln feed is tolerated regarding stability of kiln operation. Abrupt changes in kiln feed LSF may in principle be compensated by adapting the burning conditions in the kiln. Nevertheless, all effort is made to keep the burning conditions unchanged

- ◆ as each variation result in unstable coating conditions in the kiln,
- ◆ as clinker quality may temporarily deteriorate due to insufficient control of free lime.

4.2 Conceptual set-up of Kiln Dust handling systems

LSF variation in case of switching from compound to direct kiln operation also depend on the set-up of the kiln feed system and the manner in which this system is operated by the works personnel.

There is no problem in adding kiln dust to the raw meal when operating kiln and raw mill in a compound operation mode. Arrangement of the sampling station should be such that the compound material flow is sampled.

When switching from a compound to a direct operation mode or vice versa gas routing is adapted to the new operating conditions by the kiln operator but often not kiln dust routing. With the kiln in a direct operation mode kiln dust should never be fed into a raw meal silo. Neither the air-fluidised homogenising silo nor the continuous blending silo is fit to deal with kiln dust out of extended periods of direct kiln operation. The batch actually prepared in case of an air-fluidised homogenising silo will deteriorate under such conditions within a short period of time to an extent that its composition may not be corrected anymore. An important top-layer of kiln dust in an aerated gravity silo deteriorates its beneficiation effect as blending predominately takes place at product surface in such a silo.

Three conceptual set-ups have been developed for reasonable kiln dust handling:

- ◆ the separate kiln dust silo concept,
- ◆ the silo by-pass concept,
- ◆ the kiln dust dilution concept.

4.2.1 The separate kiln dust silo concept

In compound operation all the exhaust gases from the kiln pass through the raw mill. All the kiln dust is mixed with the raw mix fed to the mill. This mix is separated in the kiln dust collector and fed into the homogenising/blending silo. In addition a small portion of kiln dust out of the separate kiln dust silo is added to the raw meal ex mill prior to be fed into the homogenising/blending silo.

In direct operation the kiln exit gases are diverted directly to the kiln dust collector by-passing the raw mill (Fig. 21). At first the kiln dust separated by the dust collector is stored in a separate silo from which it is then added at a low rate to the raw meal reclaimed from the storage/blending silo. It is obvious that by doing so the kiln feed LSF is subject to a change.

When changing from a compound to a direct operation mode the concept allows for limiting the kiln feed LSF to an acceptably small variation provided the kiln dust recirculation rate is sufficiently low.

Valuation:

- + allow for keeping the compositional variations in a narrow range
- Expensive solution

Figure 21: Kiln dust handling - By-Pass with separate dust silo

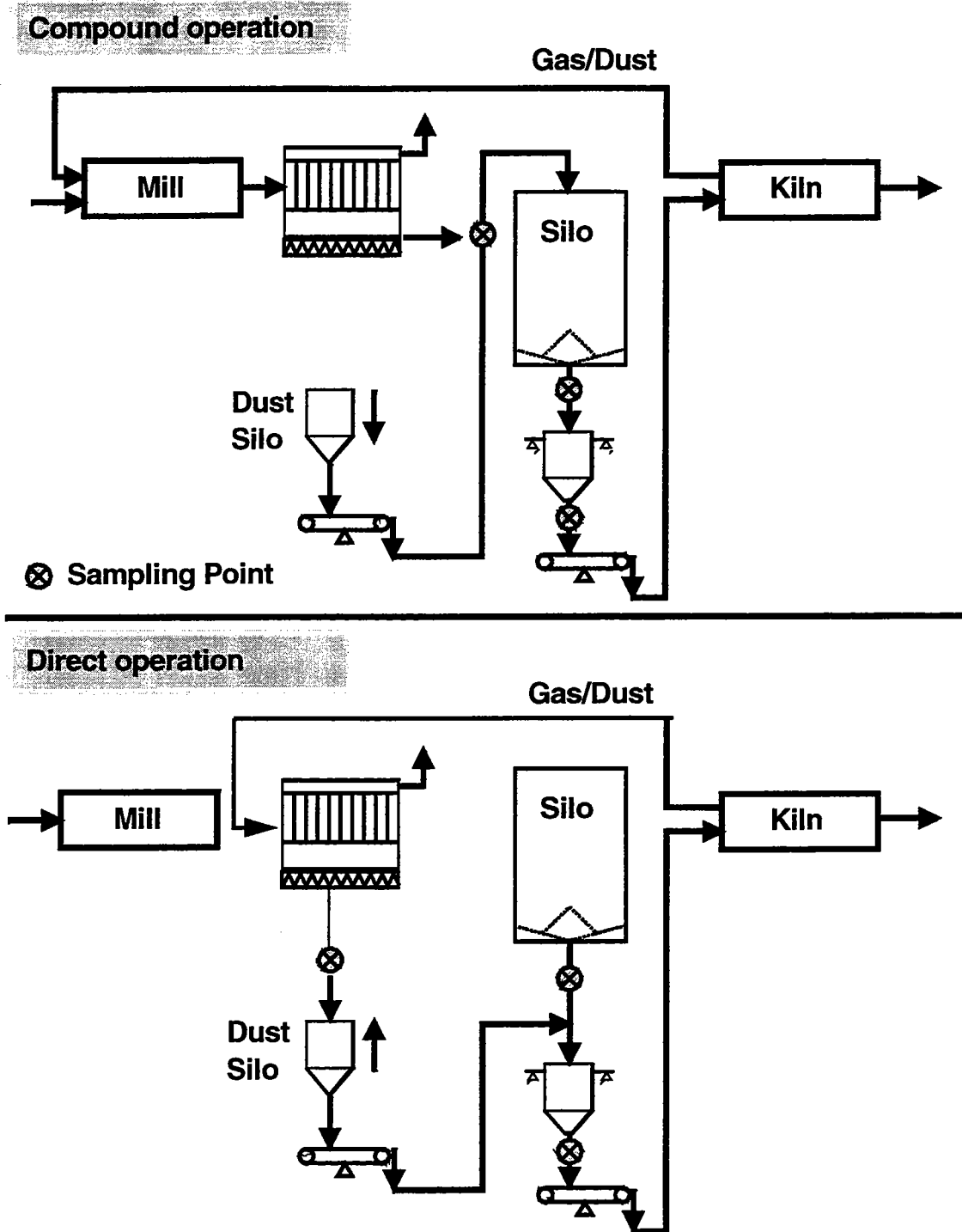

4.2.2 The silo by-pass concept

In compound operation again all the exhaust gases from the kiln pass through the raw mill and the kiln dust collector. The raw mix separated in the dust collector is then fed into the homogenising/blending silo out of which the kiln is fed.

In direct operation the kiln exit gases are diverted directly to the kiln dust collector by-passing the raw mill (Fig. 22). The kiln dust separated by the dust collector is mixed with meal reclaimed from the blending silo for being fed to the kiln.

When changing from a compound to a direct operation mode it is obvious the kiln feed LSF is subject to a change. This change may be significant and cause operational problems. But provided the system is correctly operated the meal content of the homogenising/blending silo is not subject to a compositional change. For a numerical example see Annex 2.

Valuation:

- + simple inexpensive arrangement, standard arrangement
- may in rare case result in a compositional change that can cause problems with kiln operation

Figure 22: Kiln dust handling - By-Pass without separate dust silo

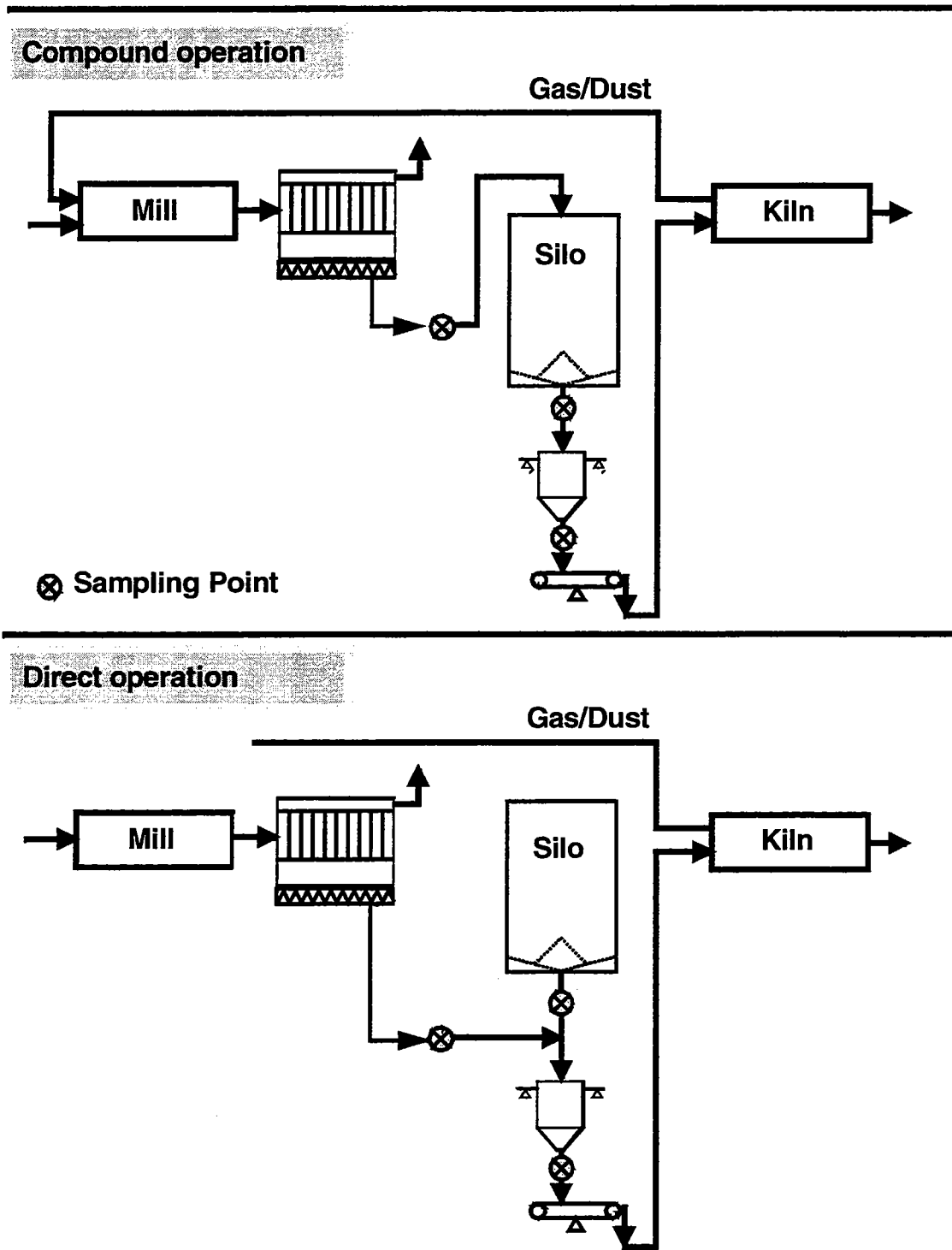

4.2.3 The kiln dust dilution concept

Compound operation is similar as for the silo by-pass concept.

In direct operation the kiln exit gases are diverted directly to the kiln dust collector by-passing the raw mill (Fig. 23). A second silo outlet is activated. The kiln dust separated by the dust collector is mixed with meal reclaimed via an additionally activated outlet from the blending silo for dilution and recirculation to the blending silo.

When changing from a compound to a direct operation mode kiln feed LSF will gradually change as will the raw meal contained in the blending silo.

Valuation:

- + simple arrangement
- +/- result in a gradually changing composition of the hold raw meal stock

Figure 23: Kiln dust handling - Dust Dilution with Raw Meal

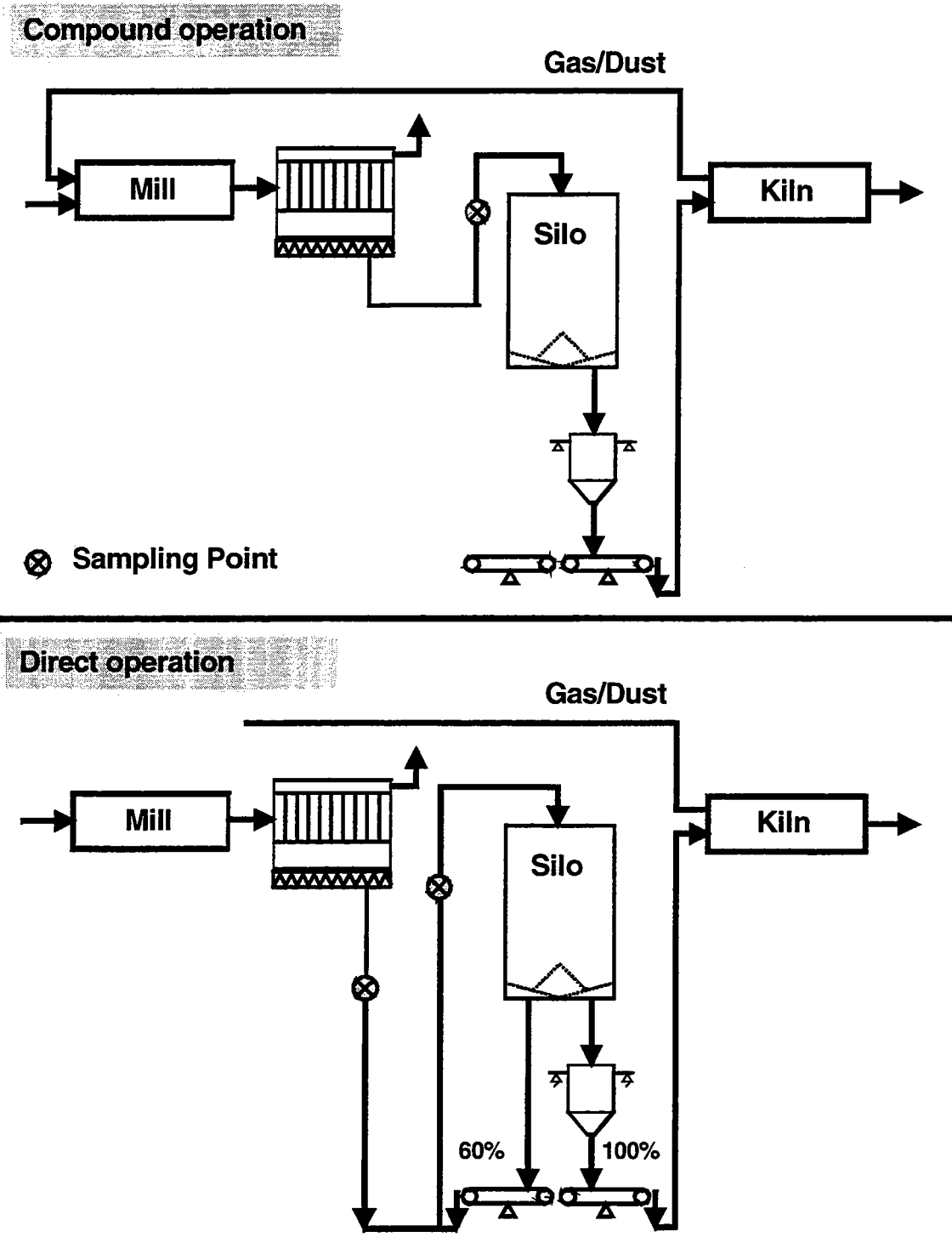

5. ANNEX

5.1 Annex 1

Testing the Blending Factor BF of Blending/Homogenising Silos

Duration: 2 x 24 h
 Permissible interruptions: 3 interruptions, but max. 90 min per test
 Sampling the silo feed product: double spot samples (2 x 100 g) once an hour
 Sampling the silo outlet product: double spot samples (2 x 100 g) once an hour
 Analysis: CaO by XRF
 Test Evaluation:

◆ Blending Factor

$$BF = \frac{S_{in,corr}}{S_{out,corr}} = \frac{\sqrt{S_{in,measured}^2 - S_{in,error}^2}}{\sqrt{S_{out,measured}^2 - S_{out,error}^2}} \quad (1) \quad \text{as blending/homogenising factor}$$

◆ Correction for the sampling and analysis error acc. to Merks double sampling method

with $S^2_{measured} = \sum_{i=1}^N \frac{(X_i - \bar{X})^2}{N-1} \quad (2) \quad \text{as variance of the measured values}$

$$X_i = \frac{1}{2}(X_{i,1} + X_{i,2}) \quad (3) \quad \text{as mean concentration of a double sample}$$

$$\bar{X} = \frac{1}{N} \sum_{i=1}^N X_i \quad (4) \quad \text{as mean concentration of all double samples}$$

$$S^2_{error} = \frac{\pi}{4} \left(\frac{1}{N} \sum_{i=1}^N |d_i| \right)^2 \quad (5) \quad \text{as error of sampling and/or analysis (acc Merks)}$$

$$d_i = (X_{i,1} - X_{i,2}) \quad (6) \quad \text{as difference in concentration for one double sample}$$

5.2 Annex 2

Effect of kiln dust on kiln feed composition

Assumptions:

average LSF of the clinker (goal value)	95	%
LSF of kiln dust	110	%
external dust circuit (LOI free)	0.1	kg/kg _{cli}
operating time of mill (5 d/w, 20 h/d)	59.5	%

Calculation:

- ◆ specific mill performance (LOI free)

$$\dot{m} = \frac{100\%}{59.5\%} = 1.68 \text{ kg} / \text{kg}_{cli}$$

- ◆ LSF of raw mix ex mill or kiln feed respectively (compound operation)

$$LSF_{CO} = \frac{1.98 \times 95\% + 0.1 \times 110\%}{1.98 + 0.1} = 95.8\%$$

- ◆ LSF difference on changing from compound to direct operation

$$\Delta LSF = LSF_{DO} - LSF_{CO} = (\dot{m}_{KD} \times LSF_{KD} + (1 - \dot{m}_{KD}) LSF_{RM}) - 1 \times LSF_{RM}$$

$$\Delta LSF = \dot{m}_{KD} (LSF_{KD} - LSF_{RM})$$

$$\Delta LSF = 0.1(110\% - 95.8\%) = 1.4\%$$

with:	LSF _{DO}	= Lime Saturation direct operation	%
	LSF _{CO}	= Lime Saturation compound operation	%
	LSF _{KD}	= Lime Saturation kiln dust	%
	LSF _{RM}	= Lime Saturation raw meal	%
	m _{KD}	= specific kiln dust rate (LOI free)	kg/kg _{cli}

- ◆ LSF of kiln feed (direct operation)

$$LSF_{CO} = \frac{1 \times 95.8\% + 0.1 \times 110\%}{1 + 0.1} = 97.1\%$$

- ◆ LSF in clinker during compound operation

$$LSF_{cli,CO} = 95.8\% - 1.4\% = 94.4\%$$

- ◆ LSF in clinker during direct operation

$$LSF_{cli,DO} = 95.8\%$$

The LSF of the clinker and the raw meal ex silo will be identical provided that the dust produced by the kiln is immediately returned to the kiln at the same quantity.

5.3 Annex 3

Operation of Raw Meal Homogenising and Blending Silos

The efficiency of a homogenising/blending silo system is mainly impaired by

- ◆ insufficient working condition of the silo system,
- ◆ insufficient operation of the silo system,
- ◆ insufficient raw mix composition control.

1 Condition of the Silo

Problem: lump formation due to water ingress into the silo

- Remedies:
- empty and clean the silo completely
 - check silo roof and wall with regard to leaks, seal the leaks and coat the silo wall

2 Raw meal distribution

Problem: non-uniform distribution of raw meal in continuous blending silos (Fig. 24)

- Remedies:
- install a guide plate in distributor box
 - check installation (level) of distributor box
 - check whether the feed spout is arranged in the centre of the distributor

3 Raw meal reclaim

Problem: raw meal lumps obstruct material flow from the silo

- Remedies:
- check and clean outlet boxes, cut-off and flow control gates with regard to foreign matters, tramp iron, hard product lumps
 - in case that product lumps check the possibility of water ingress (acc. Para 5.1.1) or install a lump breaker
 - install dryer for the aeration air

4 Aeration air supply

4.1 Problem: reduced air supply to the aeration system

- Remedies:
- check air aspiration filter on permeability and clean the filter
 - check air distribution system on permeability and clean the system
 - check pressure distribution in air distribution system

- 4.2** Problem: continuous blow-off of blower safety valve
Reason: inadequate tuning of blower capacity to silo operating conditions
Remedies:
- relief blower safety valve by a reduction of its differential pressure
 - Measure volume of excess air, reduce air rate by this volume by a proportional reduction of the blower speed (exchange of pulleys)
- 4.3** Problem: loss of aeration air
Remedies: check external air distribution systems with regard to leaks
- empty and clean the silo completely as to check the aeration system on leaks
- 5 Aeration air distribution**
- 5.1** Problem: the specific aeration air rate ($\text{m}^3/\text{m}^2\text{min}$) should be constant and not function of the silo diameter (Fig. 25.1)
Remedies: check opening of manual valves
- 5.2** Problem: faulty operation of air distribution valves resulting more than one activated sector at a time (Fig. 25.2)
Remedies: check operation of air distribution valves
- 5.3** Problem: asynchronous aeration sequence (Fig. 25.3)
Remedies: check setting of air distribution valves

Figure 24: Continuous Blending silo

Problem

Segregation due to
Not uniform
Raw meal distribution

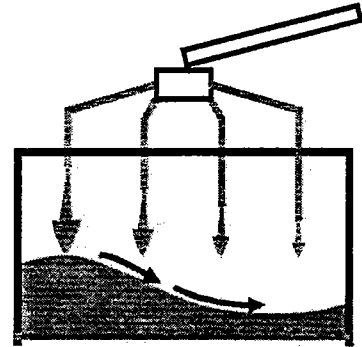

Reasons

Reduced feed rate

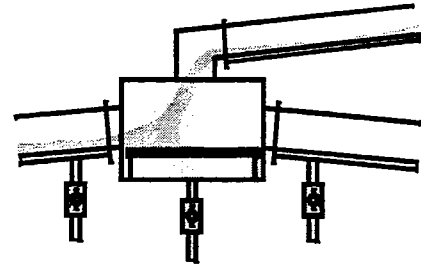

Unleveled distributor box

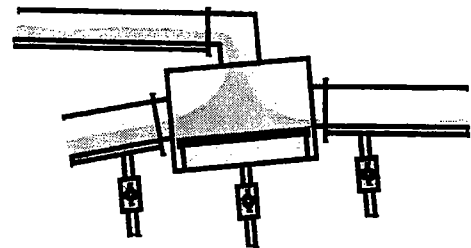

Excentric feed point

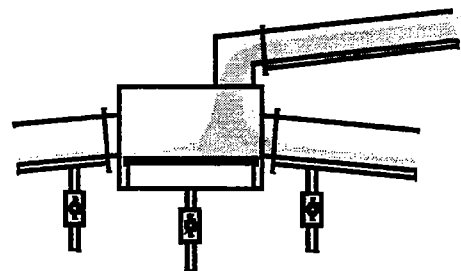
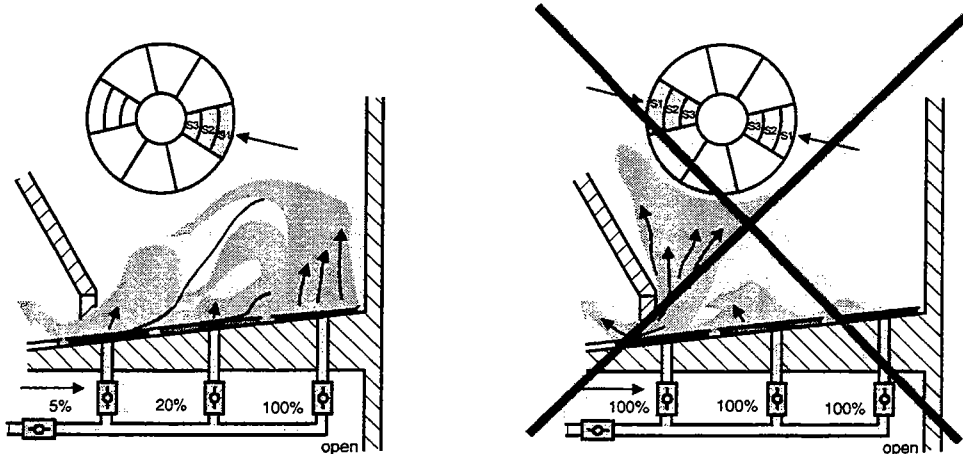

Figure 25: Continuous Blending Silos - Problems with aeration air distribution

1. Not uniform air distribution



2. Faulty operation of air distributor valves



3. Asynchronous aeration sequence

